

x1



x1



x1

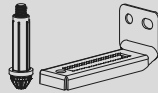

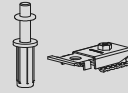

x1



x1



x3

A  x12  
 B  x6



x1

**14 kg**

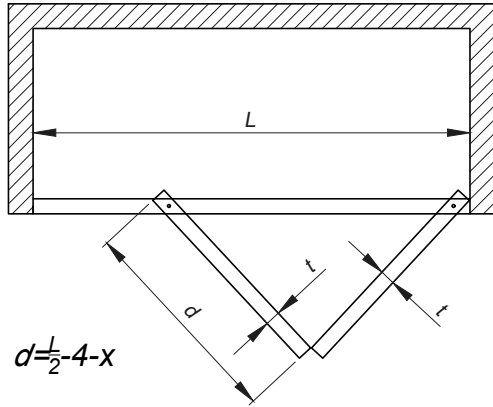

t [mm]	<28	28-30	31-38
x [mm]	0	2	4

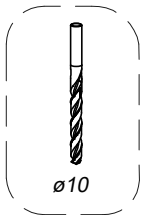
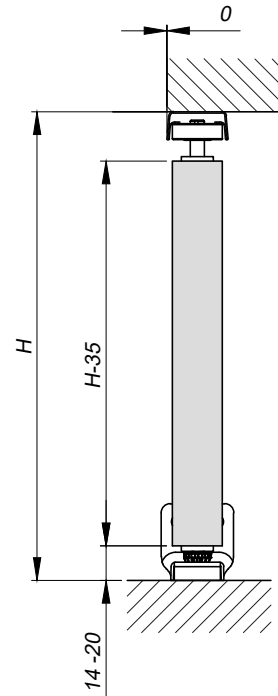

**1**

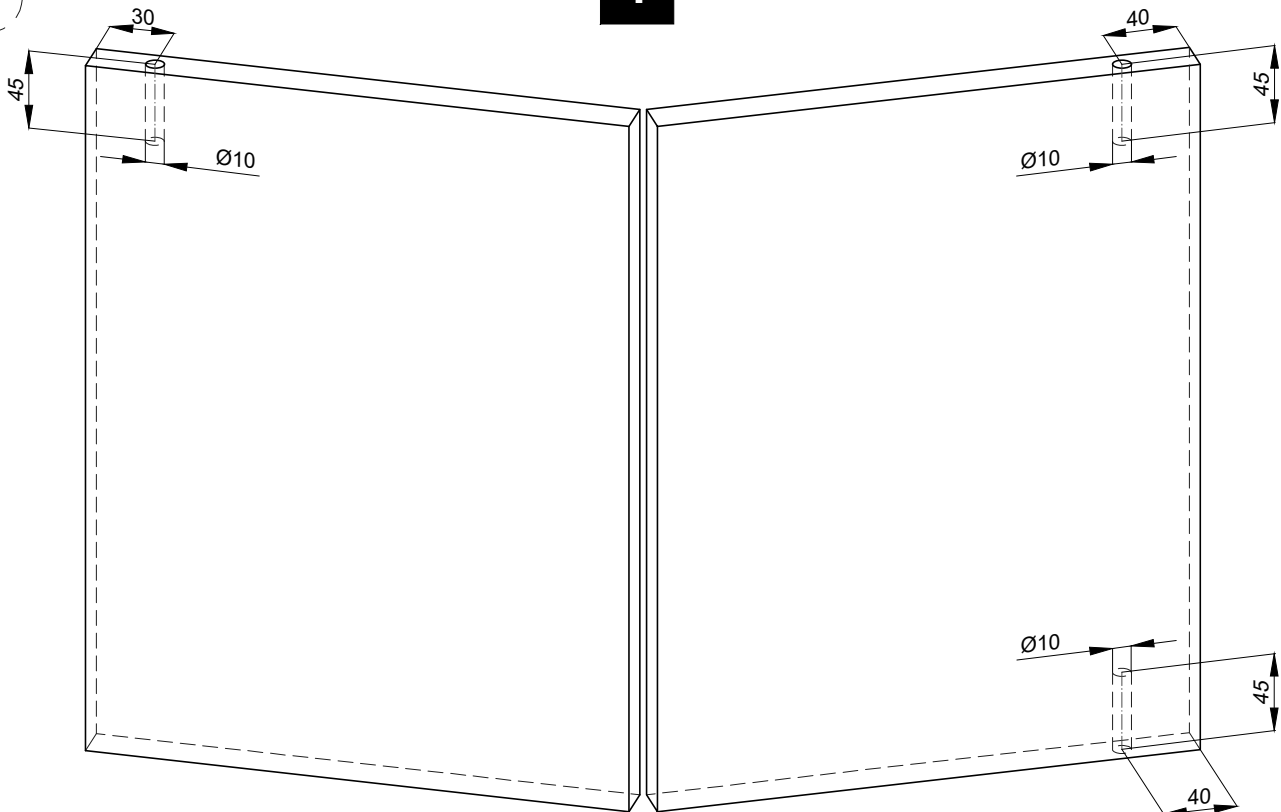

2



$t < 22$

$22 \leq t$

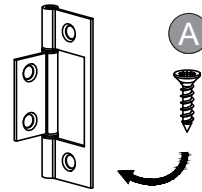
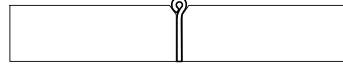
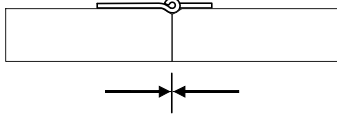

3

