



SLID'UP
BY MANTION

INSTRUCTION DE MONTAGE
MONTAGEANLEITUNG
INSTRUCTIONS FOR ASSEMBLY
INSTRUCCIONES DE MONTAJE
INSTRUKCJA MONTA U

SLID'UP 2300

SU2306

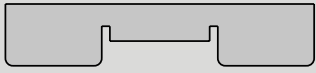

x1



x1



x1



x1

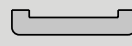

x5



x1



x3

V5 x13
Ø3.5x45



SU2300-1

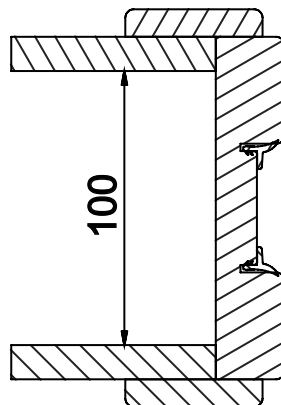
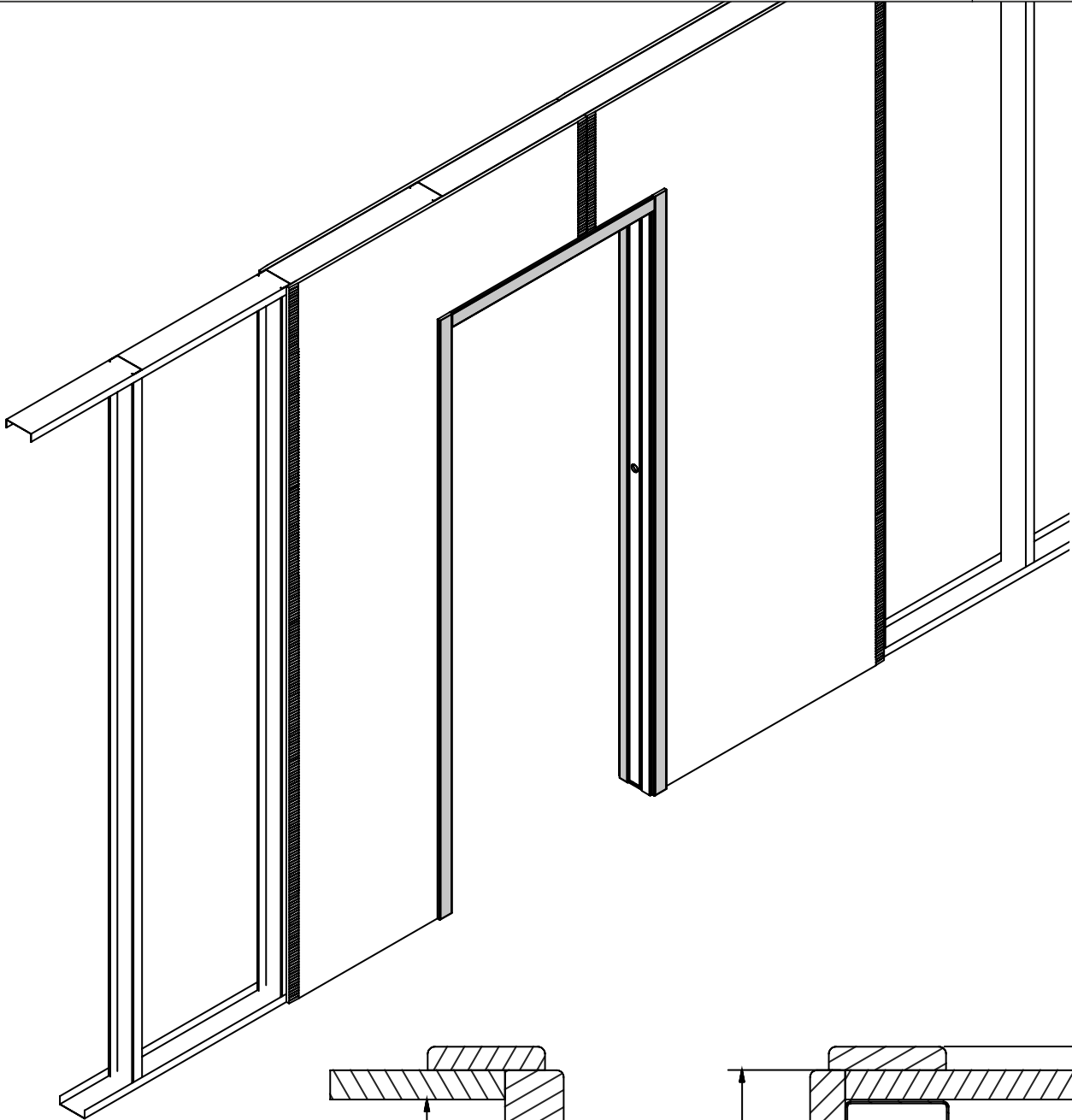

100

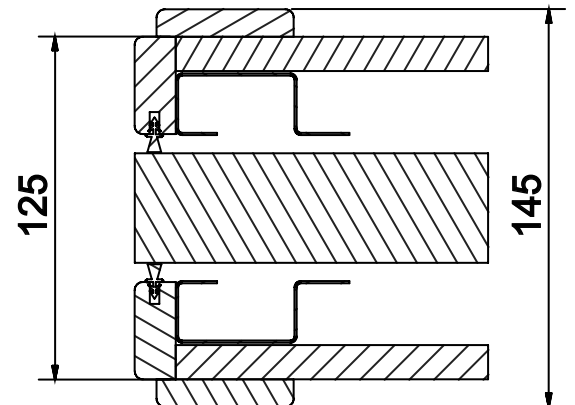

125

145



1.

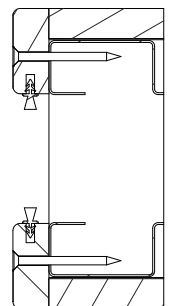
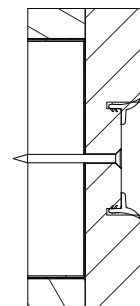
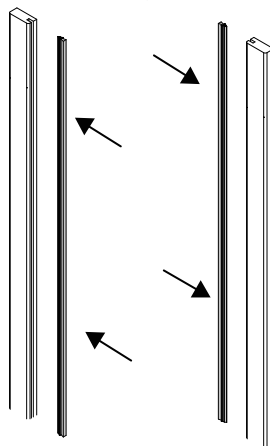
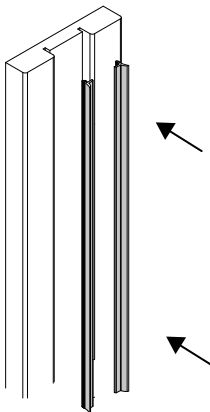
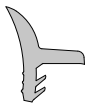
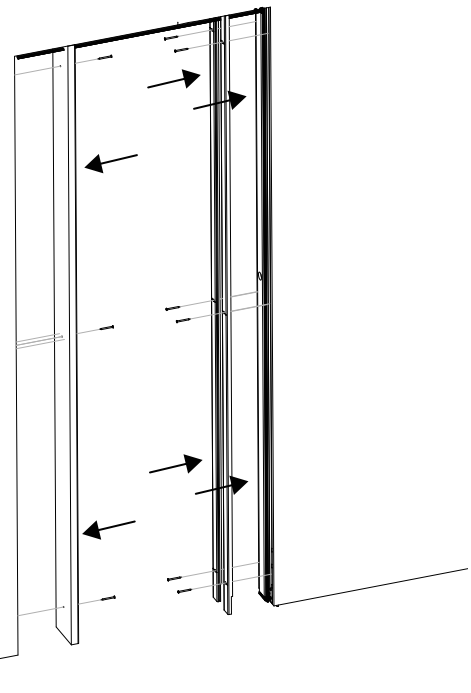
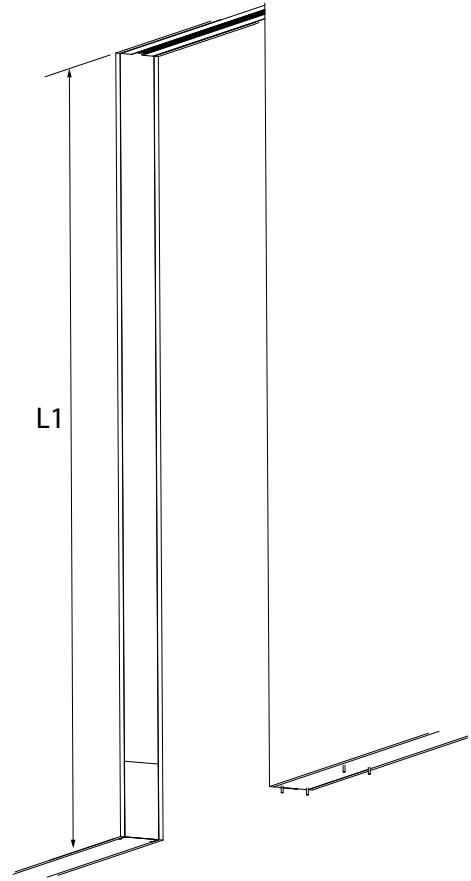
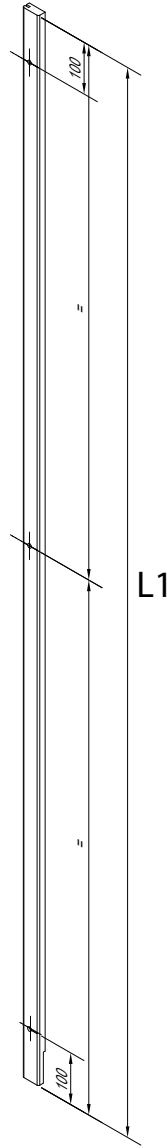
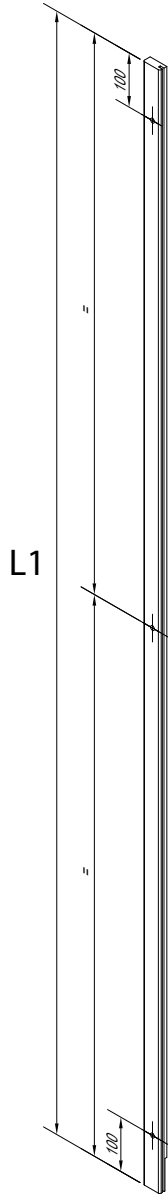
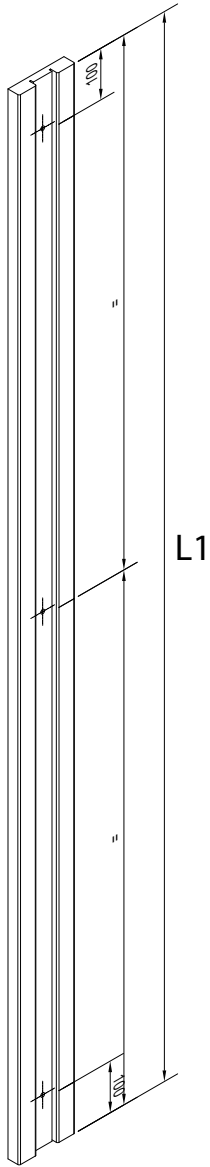
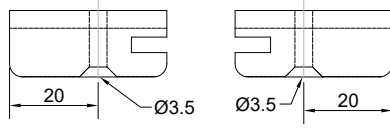
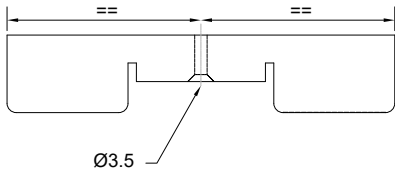

2.

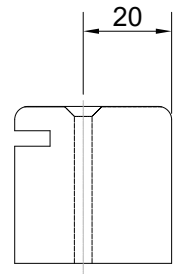
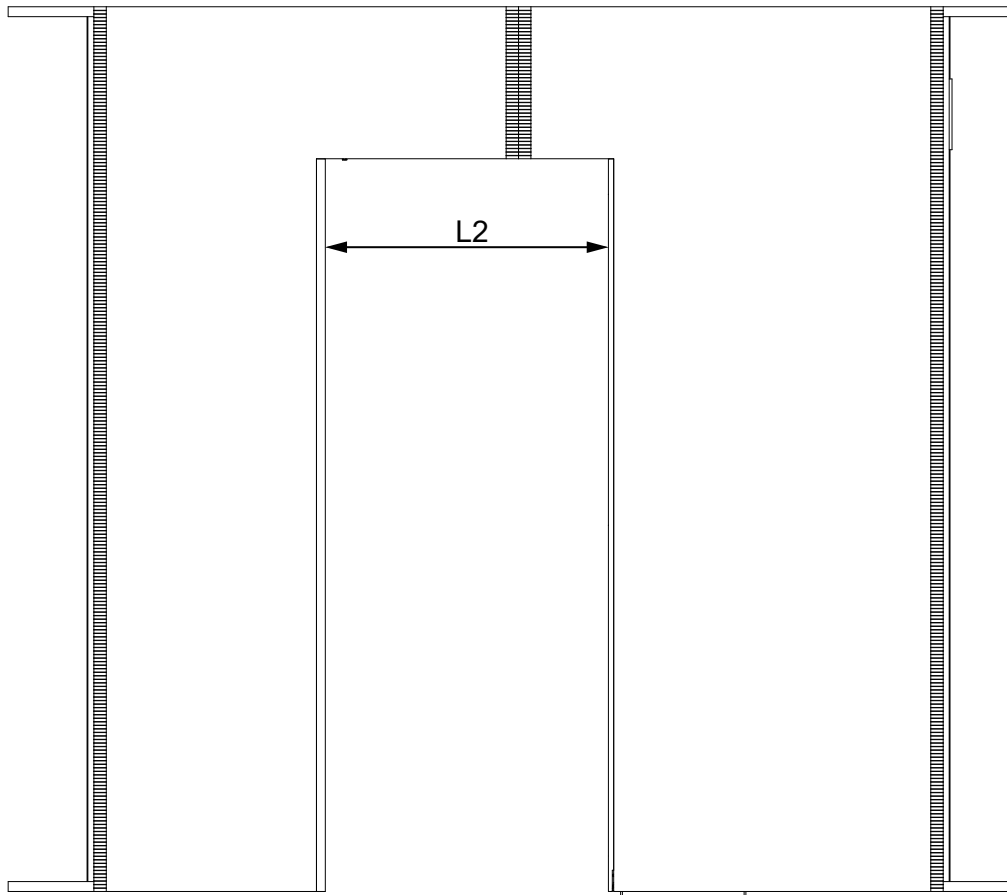

x2

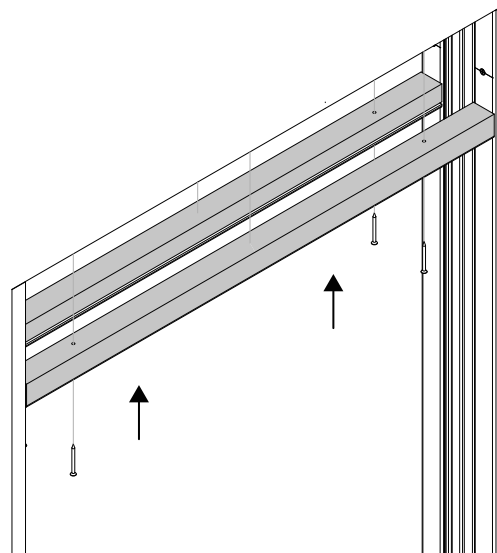
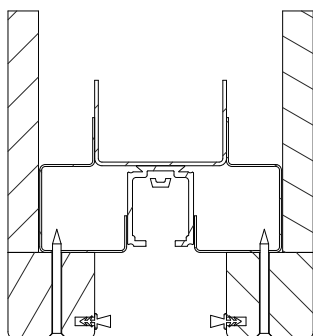
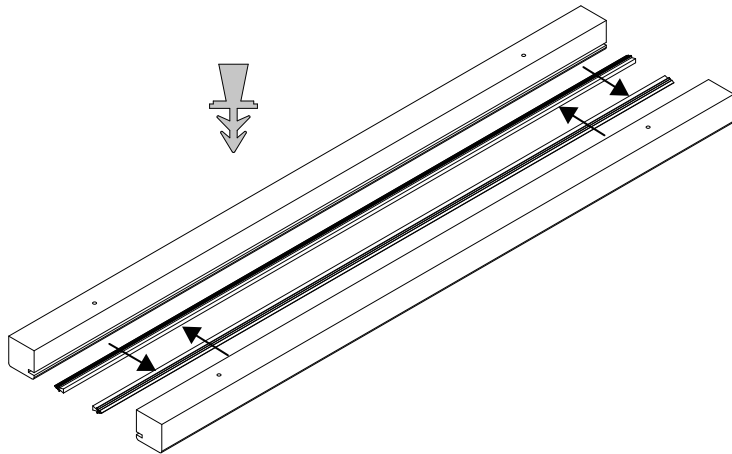
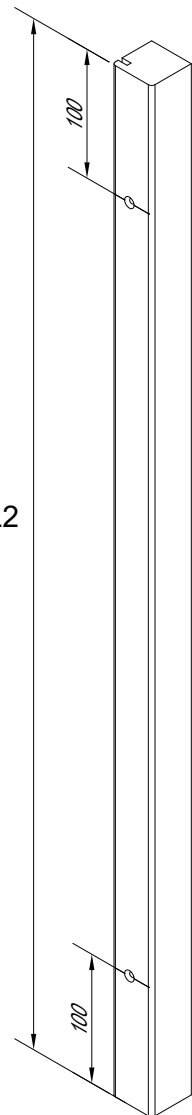

3.

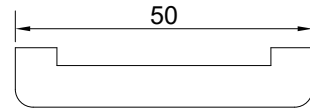

$$A = L3 + 58 \text{ mm} \times 4$$
$$B = L2 + 16 \text{ mm} \times 2$$

